

NO	NAME	QUANTITY
1	LOWER SHELF	1
2	LEG	2
3	SPOON HOLDER	1
4	TRAY	1
5	UPPER SHELF	1

1. STEP

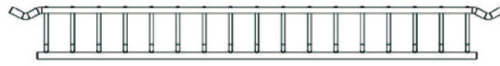

2. STEP

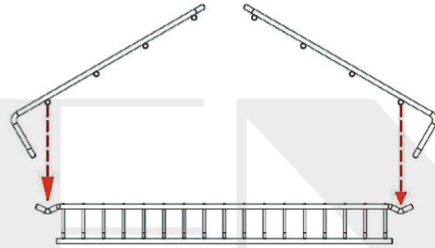

3. STEP

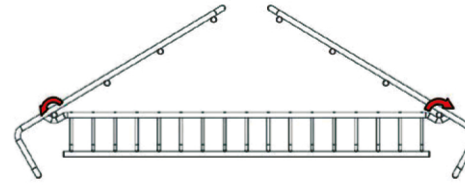

4. STEP

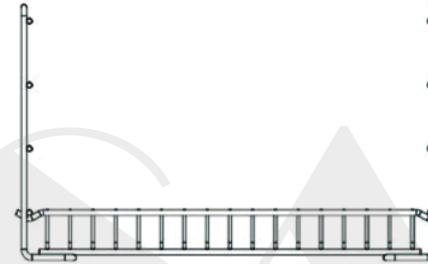

5. STEP

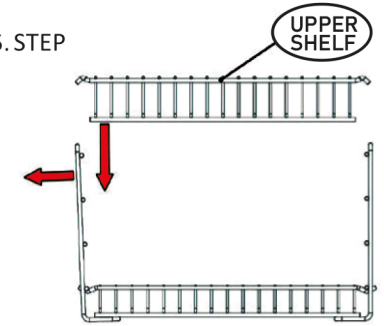

6. STEP

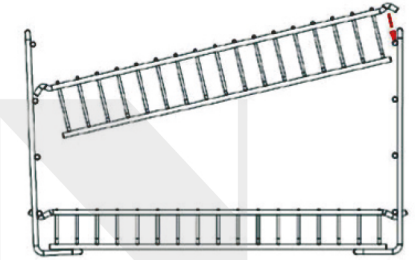

7. STEP

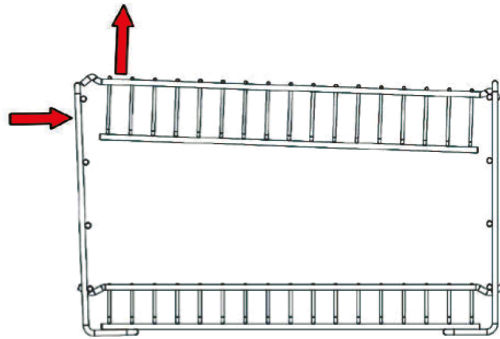

8. STEP

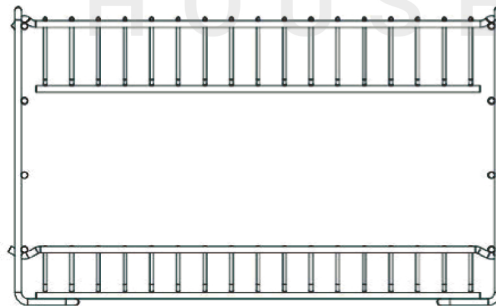

9. STEP

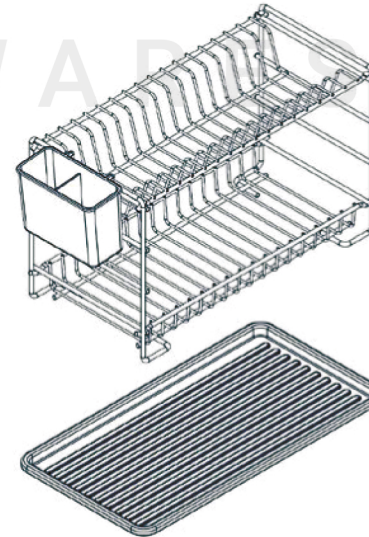

10. STEP

